

Article number: 0120042

Description: Retaining ring AL 25X1,2  
Spring steel

## Measures

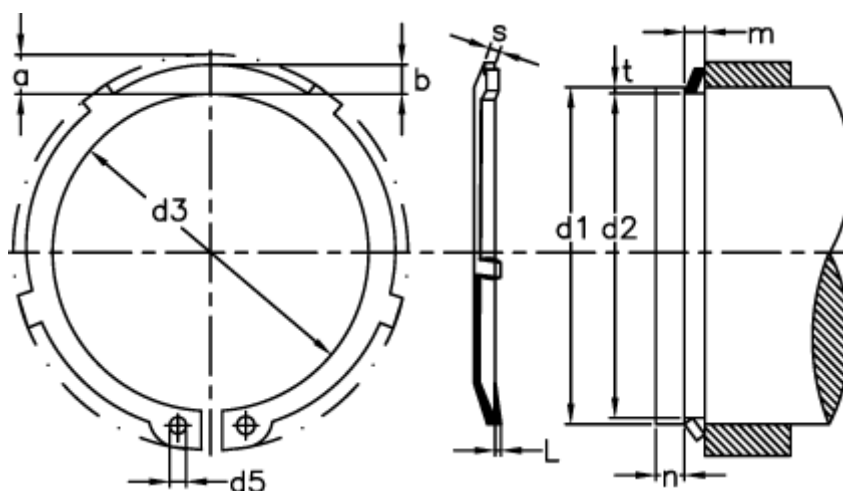

a max	= 4.3	FL max kN	= 0.66	s	= 1.20
b	= 3.0	FN kN	= 7.05	tol	= -0.21
C kN/mm	= 1.89	FRg kN	= 3.70	tol	= +0,21 -0,42
d1	= 25	FR kN	= 16.2	u	= 0.05
d2	= 23.9	g	= 1.5		
d3	= 23.2	L min	= 0.40		
d5 min	= 2.0	m min	= 1.30		
Description	= AL 25	Nominal drive	= 1.6		